

Steel backing pre-drilled for optional housing anti-rotation pin

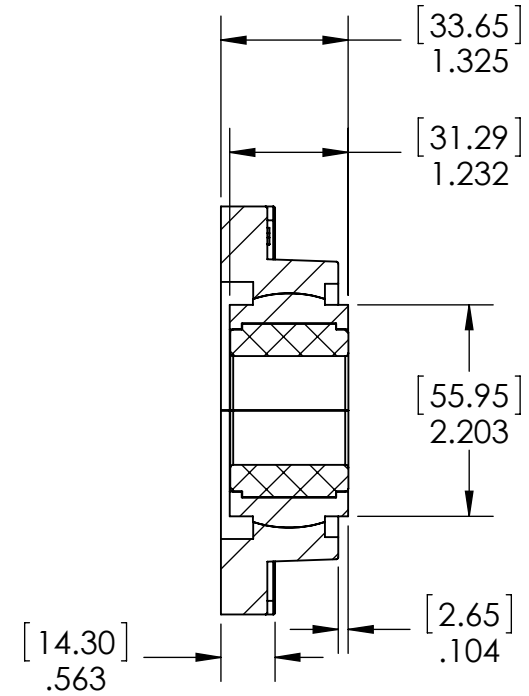
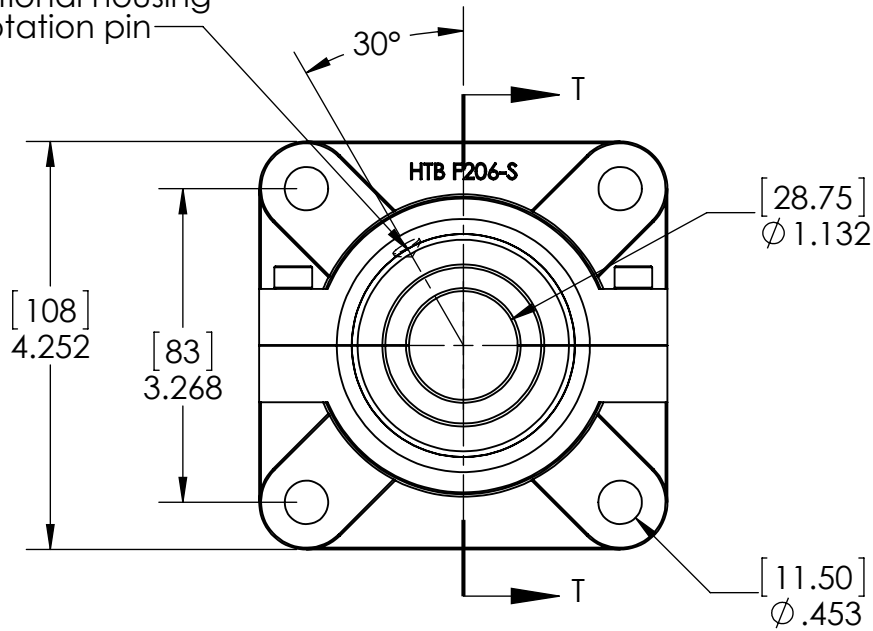

SECTION T-T
SCALE 1 : 2

Notes:

1: When ordering specify sleeve type by adding the suffix HT750, HT100 or NT600 (eg: 4BF206SHT750-112P) .

HT750: Carbon Grade rated to 750 F
 HT100: Carbon Grade rated to 1000F
 NT600: Polymer Composite Grade rated to 600F

2: 2-3 degrees of self alignment

High Temp Bearings		
TITLE: HT Split 4 Bolt Flange Steel Backed Bearing		
SIZE A	DWG. NO. 4BF206SHTxxx-112P	REV A
SCALE: 1:2		SHEET 1 OF 1